



More information on the website
radwag.com/en/info,w1,XFM





















WLC 21.X7 Precision Balance



WLC 21.X7 Precision Balance

The drawings, photos and graphics used are for illustrative purposes only.

Functions

- | | | | |
|---|---|---|--|
|  Autotest |  Dosing |  Percent Weighing |  Parts counting |
|  Peak hold |  Formulation |  Newton unit measurement |  Statistics |
|  Checkweighing |  IR sensors |  Under-pan weighing |  GLP Procedures |
|  Animal weighing |  Density determination |  Ambient conditions monitoring |  Replaceable unit |
|  Statistical Quality Control |  ALIBI Memory |  Mass for titrator |  Wi-Fi |

Datasheet

WLC 21.X7 Precision Balance	
Metrological parameters	
Maximum capacity [Max]	21 kg
Readability [d]	1 g
Verification unit [e]	-
Tare range	-21 kg
Repeatability	0,8 g
Linearity	±3 g
Stabilization time	3 s
Adjustment	external
Physical parameters	
Leveling system	manual
Display	7" graphic colour touchscreen
Weighing pan dimensions	195×195 mm
Packaging dimensions	430×270×190 mm
Net weight	2,2 kg
Gross weight	3,8 kg
Construction	
Protection class	IP 43
Components and software	
Database capacity	7
Communication interface	
Communication interface	2×RS232 ¹ , USB-A, USB-B, Ethernet, Wi-Fi
Electrical parameters	
Power supply	Adapter: 100 – 240V AC 50/60Hz 0,6A; 12V DC 1,2A Balance: 10 – 15VDC 0,6A max
Environmental conditions	
Operating temperature	+10 ÷ +40 °C

Repeatability is expressed as a standard deviation from 10 weighing cycles. Stabilization time depends on the ambient conditions and the dynamics of weighing pan loading; specified for FAST profile. 1 Barcode scanners, available as weighing instrument accessory, communicate with the instrument via RS232 interface exclusively.

* Wi-Fi® is a registered trademark of Wi-Fi® Alliance.



Accessories

Balance Storage Case
Antivibration Tables
Power Adapters
RS 232 cables (scale - printer)
Cigarette lighter receptacle power supply cables
USB cable (scale - printer)
Barcode scanners
Under-pan weighing

RS 232, RS 485 cables
Density determination KIT
Displays
Receipt Printer
RS 232, RS 485 cables
Protective cover for balances
RS 232 cables (scale - printer)
RS 232 – RS 485 Converter

Software

Device dimensions

WLC 21.X7 Precision Balance

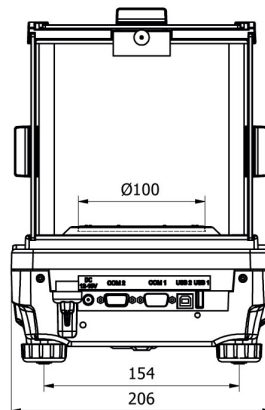
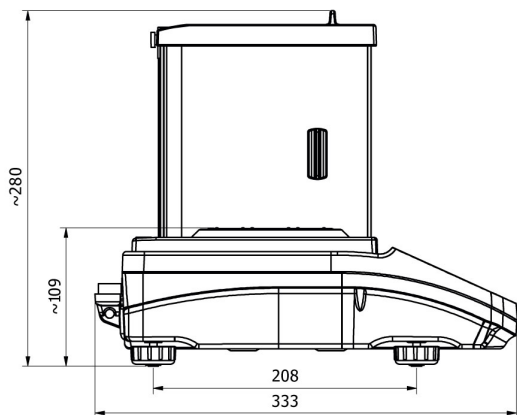

WLC X2, d = 0.001 mg

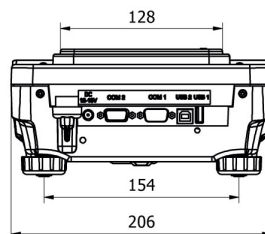
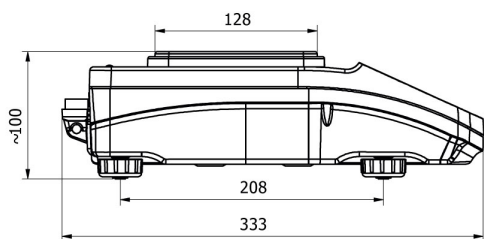

WLC X2, d = 0.01 mg

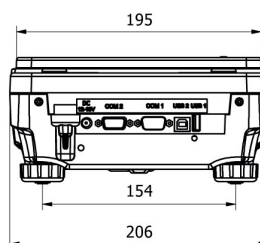
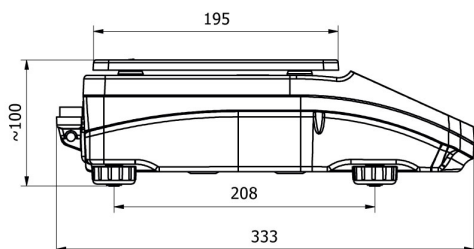

WLC X2, d = 0.1 mg