

LP263 / LP263S

Single Point Load Cell

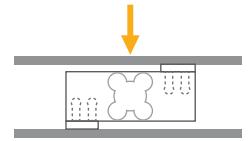

Applications



Small Bench



Large Bench



Explosive Atmospheres



Checkweighers



Tank, Bunker, Silo Weighing

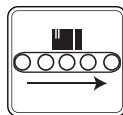

Conveyor Scales

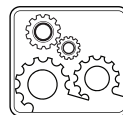

Industrial Processes

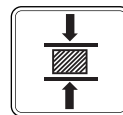

Testing Machines

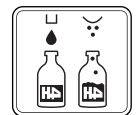

Packing & Filling Applications

Key Features

- Capacities: LP263: 50~750 kg, LP263S: 50~250 kg
- LP263: Aluminium
LP263S: Stainless steel
- EU OIML R60 C3 approval
- ATEX approved (optional)
Zone 0, 1, 2, 20, 21, 22
- Protection class: IP66
- Platform size (recommended): 600 x 600 mm

LP263 and LP263S are platform-type load cells with a wide range of capacity. LP263 has a capacity ranging from 50 kg to 750 kg while LP263S has a capacity ranging from 50 to 250 kg. Both load cell type has OIML C3 approval and IP66 protection rating. LP263, made of aluminium and LP263S, made of stainless steel, provide excellent weighing performance in single-load cell platform applications.

ATEX approved LP263 / LP263S load cells are suitable for use in explosive environments.

Technical Specifications

Model		LP263		LP263S
Maximum Capacity (E_{max})	kg	50 / 100	150 / 200 / 250 / 300 / 500 / 750	50 / 100 / 150 / 200 / 250
Accuracy class		G3	C3	C3
Maximum number of load cell verification intervals (n_{LC})		-	3000	3000
Minimum load cell verification interval (v_{min})		-	15000	10000
Maximum division number (d)		3000	-	-
Rated output (RO)	mV / V	2 ± 0.2		
Temperature effect on zero	$\%E_{max} / 10^\circ C$	≤ 0.017		
Temperature effect on sensitivity	$\%E_{max} / 10^\circ C$	≤ 0.02	≤ 0.017	
Combined error	$\%E_{max}$	< 0.02		
Creep error (30 minutes)	$\%E_{max}$	≤ 0.02	≤ 0.016	
Zero balance	$\%RO$	≤ 3		
Input resistance	Ω	404 ± 10		383 ± 10
Output resistance	Ω	350 ± 3		
Insulation resistance (at 50 V DC)	M Ω	≥ 2000		
Safe load limit	$\%E_{max}$	150		
Ultimate load	$\%E_{max}$	300	200	
Excitation voltage, recommended	V (DC)	5 - 10		
Excitation voltage, maximum	V (DC)	15		
Compensated temperature range	$^\circ C$	- 10...+ 40		
Operating temperature range	$^\circ C$	- 20...+ 50		
ATEX Approval (Optional)		ATEX  II 1G Ex ia IIC T6 Ga II 1D Ex ia IIIC T82 $^\circ C$ Da		
Material		Aluminium		Stainless steel
Protection class		IP66		
Cable		Length: 2 m / \varnothing 5mm		Length: 3 m / \varnothing 5mm
Maximum platform size	mm	600 x 600		

Dimensions (mm)

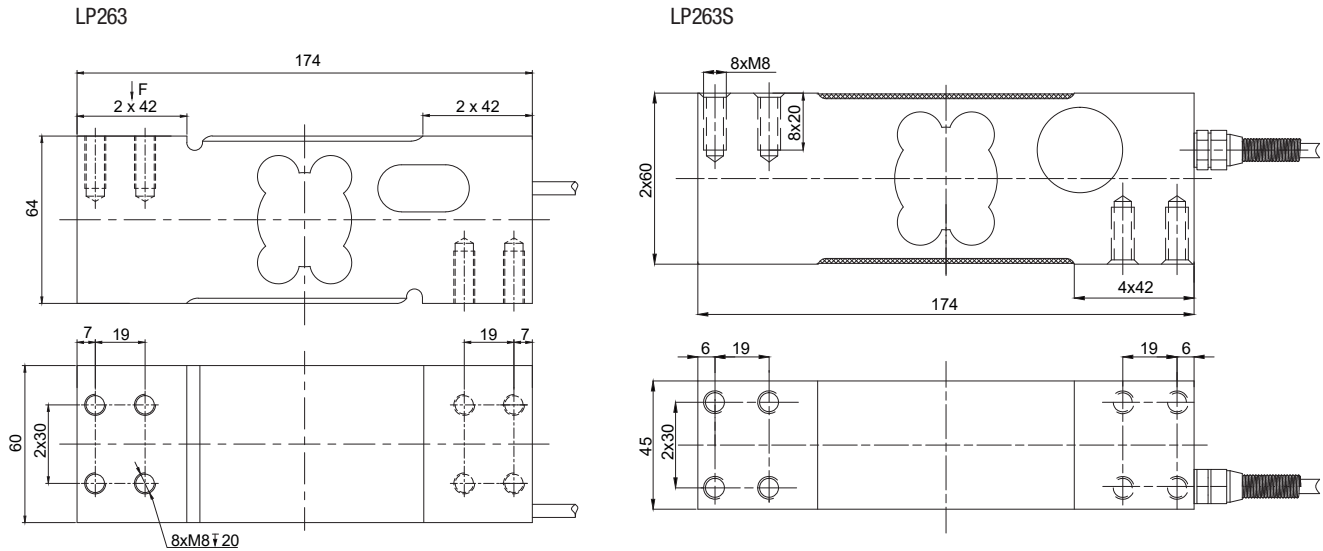

Color Codes

Function	Colors
+ input	blue
+ output	white
- input	black
- output	red
shield	