

LP022

Single Point Load Cell

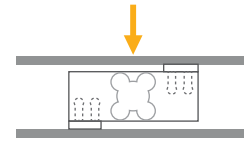

Applications



Small Bench



Large Bench



Explosive Atmospheres



Checkweighers

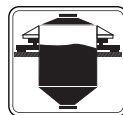

Tank, Bunker, Silo Weighing

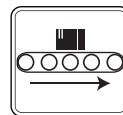

Conveyor Scales

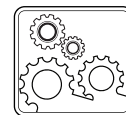

Industrial Processes

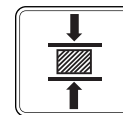

Testing Machines

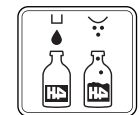

Packing & Filling Applications

Key Features

- Capacities; 8~40 kg
- Aluminum
- OIML R60 C3 approved
- ATEX approved (optional)
Zone 0, 1, 2, 20, 21, 22
- Protection class; IP66
- Platform size (recommended): 300 x 300 mm

LP022 is aluminium single point load cell with IP66 protection. It is suitable for bench scales, counting scales, balances, packing machines and testing devices for force measurement.

ATEX approved LP022 load cell is suitable for use in explosive environments.

Technical Specifications

Model		LP022	
Capacity (E _{max})	kg	3 / 5	8 / 10 / 15 / 20 / 30 / 35 / 40
Accuracy class		G3	C3
Rated output (RO)	mV / V	2.0 ± 0.2	
Max. number of load cell verification intervals (n _{LC})		-	3000
Min. load cell verification interval (V _{min})		-	E _{max} / 10000
Temperature effect on zero	%RO / 10°C	≤ 0.01	
Temperature effect on sensitivity	%RO / 10°C	≤ 0.01	
Combined error	%RO	≤ 0.017	
Safe load limit	%E _{max}	150	
Ultimate load	%E _{max}	300	
Zero balance	%RO	≤ 2.0	
Creep error (30 minutes)	%RO	≤ 0.01	
Excitation voltage, recommended	V (DC)	5 - 10	
Excitation voltage, maximum	V (DC)	15	
Input resistance	Ω	404 ± 15	
Output resistance	Ω	350 ± 3	
Insulation resistance (at 50 V DC)	MΩ	≥ 2000	
Compensated temperature range	°C	- 10...+ 40	
Operating temperature range	°C	- 20...+ 50	
ATEX Approval (Optional)		ATEX  II 1G Ex ia IIC T6 Ga II 1D Ex ia IIIC T82°C Da	
Material		Alüminyum	
Protection class		IP66	
Cable		Shielded, 4 conductor cable, length: 1 m / diameter: 5 mm	
Maximum platform size	mm	300 x 300	

Dimensions (mm)

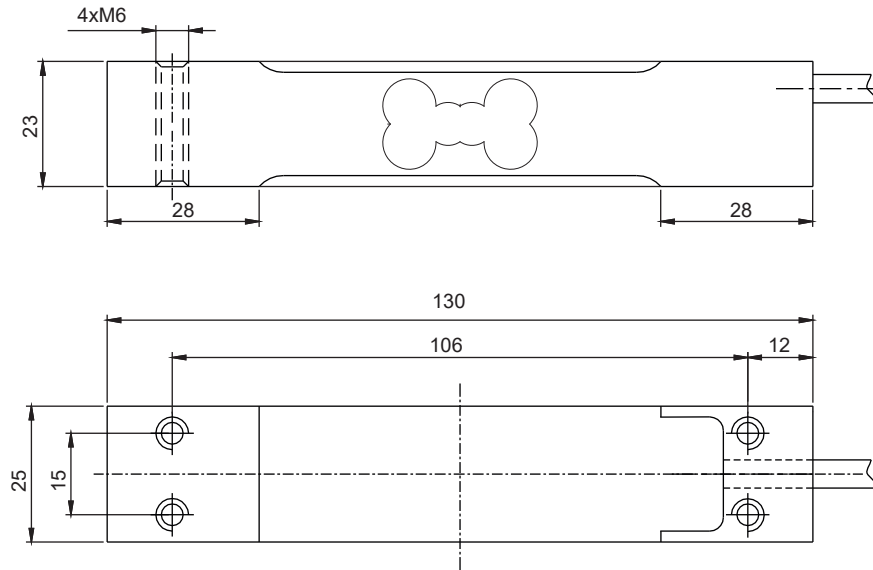

Color Codes

Function	Colors
+ input	blue
+ output	white
- input	black
- output	red
shield	